

F.No. 16-40/2012-O&M
Government of India
Ministry of Communications & IT
Department of Telecommunication

516, Sanchar Bhawan
20- Ashoka Road
New Delhi

Dated 14th May, 2013

OFFICE MEMORANDUM

Subject:- Induction Material.

The undersigned is directed to forward herewith a copy of Induction Note of the Department of Telecommunications as on 1st April, 2013 for information.



(A.K. Singh)
Under Secretary (C&A)

To

1. Member (T)
2. Member (F)
3. Member (S)
4. Administrator USOF
5. AS (T)

Copy along with a copy of the Induction Note to –

6. PPS to Secretary (T)
7. Director (IT) for placing in the website of DOT.

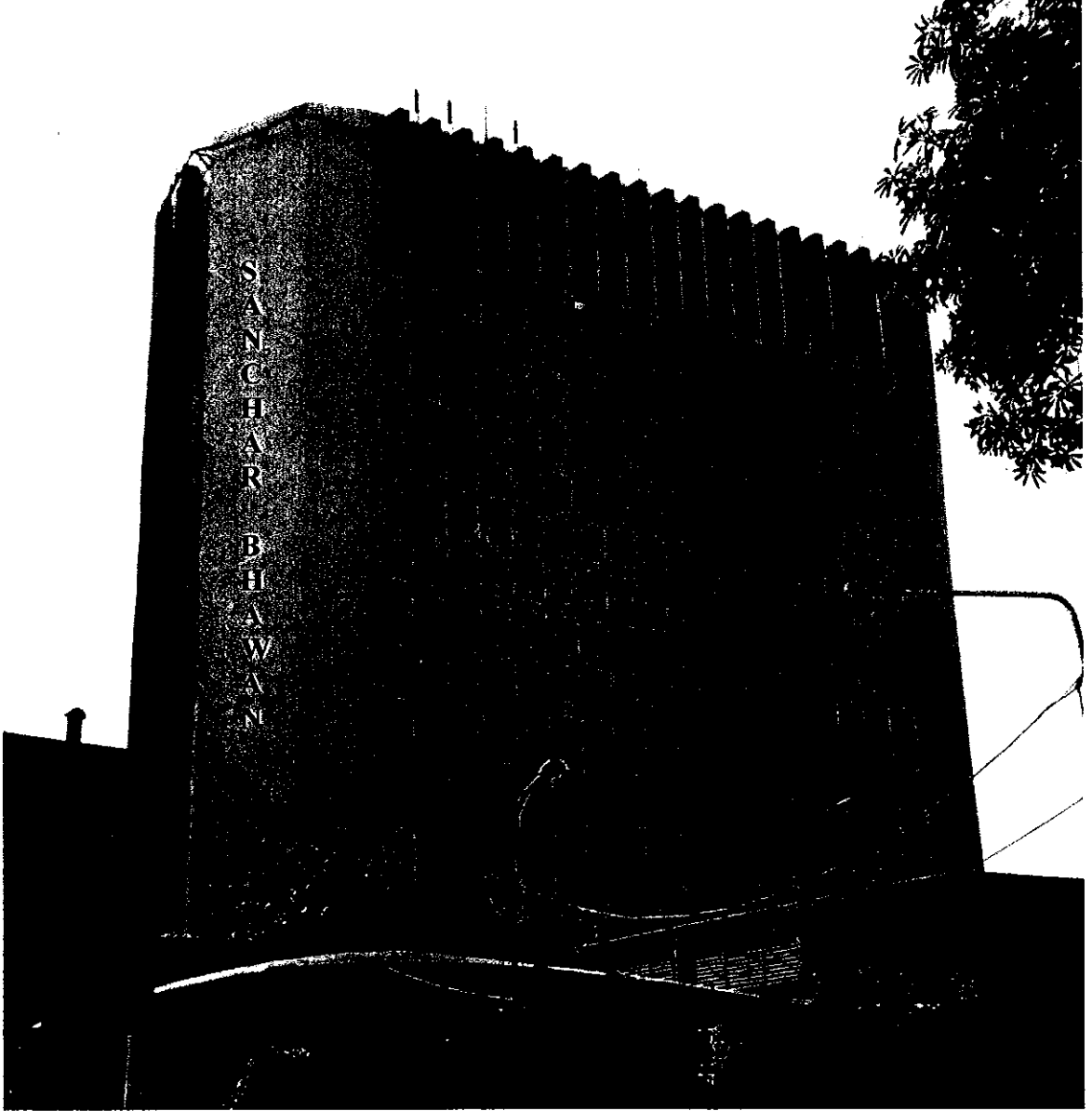

INDUCTION NOTE

(As on 1st April, 2013)

भारत सरकार
सूचना एवं प्रौद्योगिकी मंत्रालय
दूरसंचार विभाग
Government of India
Ministry of Communications & IT
Department of Telecommunications

INDEX

<u>Sl.No.</u>	<u>Subject</u>	<u>Page No.</u>
1.	Executive Summary	2-7
2.	Attached Offices	8-11
	i) Telecom Engineering Centre (TEC),	
	ii) Universal Services Obligations Funds (USOF)	
3.	Subordinate Offices	12-13
	i) Wireless Monitoring Organisation (WMO)	
4.	Field Offices	14-15
	i) Controller of Communication Accounts (CCA) Offices	
	ii) Telecom Enforcement Resource Monitoring (TERM) Cells	
5.	Public Sector Undertakings (PSUs)	16-21
	i) Bharat Sanchar Nigam Limited (BSNL),	
	ii) Mahanagar Telephone Nigam Limited (MTNL),	
	iii) Telecommunications Consultants India Limited (TCIL),	
	iv) Indian Telephone Industries (ITI),	
	v) Bharat Broadband Nigam Limited (BBNL)	
6.	Statutory Bodies	22-24
	(i) Telecom Regulatory Authority of India (TRAI)	23
	(ii) Telecom Disputes Settlement and Appellate Tribunal (TDSAT)	24
7.	Autonomous Body	
	Centre for Development of Telematics (C-DOT)	25-27
8.	Allocation of Business Rules	Annexure- A 28-29
9.	Organization Chart	Annexure- B 30
10.	Work Allocation	Annexure- C 31-55
11.	PSUs/Statutory Bodies/Autonomous Under DoT	Annexure – D 56

**DEPARTMENT
OF
TELECOMMUNICATION**



सत्यमेव जयते

INDUCTION NOTE

(As on 1st April, 2013)

Executive Summary

1. Structure:

The structure of the Department of Telecommunications is unique in that besides being a conventional Department, it has a high level decision making body in the form of the Telecom Commission (TC). The Telecom Commission (TC) was set up through Government's Resolution dated 11th April, 1989. The Secretary, DOT is the ex-officio Chairman of the Commission. The Commission has four full time Members who are ex-officio Secretaries to the Government of India in the Department of Telecommunications. The Commission also has four part time Members i.e. Secretary (IT), Secretary (Finance), Secretary (Planning Commission) and Secretary (IP&P). The Additional Secretary, DOT is the Secretary of the Commission.

The Commission is vested with the administrative and financial powers of the Government to deal with various aspects of Telecommunications. The Chairman, in his capacity as Secretary to the Government of India in the Department of Telecommunications, is responsible under the Minister of Communications for arriving at decisions on technical questions and advising Government on policy and allied matters of telecommunication. All recommendations of the Commission on policy and allied matters shall be put up to the Minister of Communications through the Chairman.

2. Functions of the Telecom Commission and of the DOT:

The **Telecom Commission** is vested with the administrative and financial powers of the Government to deal with various aspects of Telecommunications. The **Chairman**, in his capacity as Secretary to the Government of India in the Department of Telecommunications, is responsible under the Minister of Communications for arriving at decisions on technical questions and advising Government on policy and allied matters of telecommunications. All recommendations of the Commission on policy and allied matters shall be put up to the Minister of Communications through the Chairman.

Earlier till 30th September, 2000, DOT was also performing the role of service provider besides policy making functions. In 1986, Mahanagar Telephone Nigam Limited (MTNL) was formed for providing Telecommunications services in Delhi and Mumbai. Subsequently the service provider function of DOT in the rest of the country was hived off to a new corporate entity i.e. Bharat Sanchar Nigam Limited (BSNL) on 1st October, 2000.

A copy of the **Allocation of the Business Rules** is placed at Annexure-“A”.

Currently, the **main functions** of DOT are policy formulation, licensing and coordination matters relating to Telecommunications, wireless spectrum management, administration of the Indian Telegraph Act, 1885, Indian Wireless Telegraphy Act, 1933 and Telecom Regulatory Authority of India Act, 1997 and operationalisation of Universal Service Obligation (USO) Fund. DOT is also responsible for matters relating to its PSUs namely Bharat Sanchar Nigam Limited (BSNL), Mahanagar Telephone Nigam Limited (MTNL), Telecommunications Consultants India Limited (TCIL), Indian Telephone Industries Limited (ITI), Bharat Broadband Network Ltd (BBNL) and Centre for Development of Telematics (C-DOT), an autonomous body.

The Telecommunications Engineering Centre (TEC) is an S&T institution under the Department, while the Universal Service Obligation (USO) Fund is administered by the office of the Administrator, USO fund. Both these are attached offices of the

Department. The two statutory bodies i.e. the Telecom Regulatory Authority of India (TRAI) and Telecom Disputes Settlement and Appellate Tribunal (TDSAT) are under the administrative control of the Department. DOT is also responsible for promotion of international cooperation, private investment and standardization and research in the field of Telecommunications.

3. Organizational Chart and Work Allocation:

The Organization chart of the Department of Telecom is at **Annexure-“B”** and the work allocation among Members/JSs/DDGs is at **Annexure-“C”**. The chart showing organizational structure of Public Sector undertakings, Regulatory bodies and autonomous body under this Deptt. is at **Annexure-“D”**.

4. Work Distribution:

Within DOT, work distribution amongst the full time Members of the Telecom Commission and the Additional Secretary is as follows:

- 4.1 Member (Technology)** is responsible for Wireless Wing, all matters relating to TEC and matters pertaining to international relations in Telecom sector. He is also responsible for Licensing of Telecom Services and Cadre Control of Civil, Electrical and Architectural Services.
- 4.2 Member (Services)** is responsible for vigilance matters for DOT and PSUs, Public Grievances, administration of Indian Telegraph Act. He is responsible for cadre control of all Telecom sector services except P&T Accounts and Finance Service and Electrical, Civil and Architectural services and matters relating to staff unions and federations. Also Administrative matters relating to ITI, C-DOT & TCIL.
- 4.3 Member (Finance)** is responsible for financial advice, budget, accounting matters, cadre control of P&T Accounts and Finance Service, Economic Research Unit, audit matters and financial issues relating to PSUs of the Department and C-DOT.

4.4 Additional Secretary is responsible for administrative matters of the Department and matters relating to Telecom Commission. He is also responsible for Telecom Policy formulation and its implementation, investment promotion in Telecom manufacturing, WTO matters and matters relating to policy frame work and finalization of target on key policy issues of the Department.

5. Telecom Policy:

In 1994 Government announced the **National Telecom Policy - NTP 1994**. The important objectives envisages telephone on demand, provision of world class services at reasonable prices, ensuring India's emergence as a major manufacturing/export based on telecom equipment and universal availability of basic telecom services to all villages. It also recognized that funds required would not be available out of Government sources and involvement of private sector was required to bridge the resource gap.

Accordingly, Government invited private sector participation in a phased manner from the early nineties.

The **National Telecom Policy 1999 (NPT-1999)** was necessitated inter-alia due to non-fulfillment of certain objectives of NTP 1994 and also due to the fact the far reaching developments had taken place in the telecom and allied sectors. The main objectives of NTP 1999 included availability of affordable and effective communications for citizens, development of Telecommunications in remote, hilly and tribal areas of the country, creation of modern and efficient Telecommunication infrastructure taking into account the convergence of IT, media, Telecom and consumer electronics. It also included transformation in a time bound manner of the Telecommunication sector to a greater competitive environment providing equal opportunities and level playing field for all players, strengthening of Research & Development efforts, providing impetus to build world class manufacturing capabilities, achieving efficiency and transparency in spectrum management etc.

Most of the quantified targets for NTP 1999 have been achieved. In pursuance of NTP 1999 service provision function of DOT was hived off to a new corporate entity BSNL.

National Telecom Policy-2012 (NTP-2012) has been approved by the Government on 31.05.2012.

The primary objective of NTP-2012 is maximizing public good by making available affordable, reliable and secure telecommunication and broadband services across the entire country. The main thrust of the Policy is on the multiplier effect and transformational impact of such services in furthering the national development agenda while enhancing equity and inclusiveness.

6. Important Policy Initiatives:

(a) In order to enable rapid growth of the telecom sector, increased competition to benefit the customers and for ensuring affordable & quality service the following policy initiatives have been taken by the Department:-

- Elimination of cap on the number of Telecom access providers in any service area.
- Permission of use of dual technology spectrum under the same UAS/CMTS licence granted to 8 companies including BSNL & MTNL.
- Guidelines issued for intra services area Merger of Cellular Mobile Telephone Service (CMTS)/Unified Access Services (UAS) Licences.
- Licences have been issued for Mobile Number Portability (MNP) service.
- Committee constituted for Allocation of Spectrum to access services providers and Spectrum Pricing.
- Provision of Mobile service within 500 meters of international border within Indian Territory has been permitted.
- The Government had released guidelines for 3G/BWA spectrum. The issues of reserve price, number of blocks for auction etc. are to be considered by the Group of Ministers.

- Broadband Policy has been issued in 2004.

(b) **Investment Policy**

The Government has increased FDI limit for telecom services upto 74%. Foreign Direct Investment (FDI) upto 49% is permitted under automatic route and proposals for FDI beyond 49% upto 74% shall be considered by FIPB on case to case basis. 100% FDI permitted for telecom equipment manufacturing under automatic route.

(C) **Universal Service Obligation Fund Initiatives**

- The Universal Service Obligation (USO) Fund is used to subsidize the development in the telecom sector in the rural areas.
- Agreement signed on 20.01.2009 with BSNL to provide 8,61,459 broadband connections to Government Institutions and individual users.
- About 5,40,000 VPTs are currently eligible for financial support for operation and maintenance. Out of 62302 uncovered villages, under Bharat Nirman Scheme(Revised December, 2009), 62,101 VPTs have been provided by BSNL as on 31st August, 2012.

(d) **Absorption of Group 'A' officers from DOT to MTNL/BSNL -**

While the absorption process of Group B, C & D employees from DOT to BSNL is complete, the absorption of Group 'A' to BSNL and MTNL is under process of operationlisation of absorbee ITS Officers who opted for Government service.

ATTACHED OFFICES

- **Telecommunications Engineering Centre (TEC)**
- **Universal Service Obligation Fund (USOF)**

Telecommunications Engineering Centre (TEC)

Telecommunication Engineering Centre (TEC) is the ISO 9000:2008 certified technical wing of DOT. TEC provides technical support to DOT and other government departments. TEC formulates Generic Requirements (GR) and Interface requirements (IR) for telecom equipment, networks, systems and services, to be deployed in Indian telecom network, on the basis of international standards. TEC also tests these for conformance, performance and interoperability according to the aforesaid requirements and certifies them.

TEC has eight Core Technical Divisions which carry out the activities of formulation of technical requirements and provision of technical support to various government departments and service providers, in relevant streams. Three other technical Divisions take care of testing and certification activities. Four Regional Centres, at New Delhi, Kolkata, Bengaluru and Mumbai, carry out testing and certification activities in the four zones of India.

In addition to the above, TEC is currently handling following additional major activities:

- a. Taking necessary steps regarding migration of networks of all service providers and government departments from IPv4 to IPv6.
- b. Setting up NGN Test-bed for testing and certification of telecom equipment for conformance, performance and interoperability.
- c. Setting-up a lab for measurement of Specific Absorption Rate (SAR) parameter for mobile handsets, which have been self-certified by the respective manufacturers and importers.
- d. Issued necessary standards and procedures for measurement of Electromagnetic field Radiation (EMF) radiation from cellular mobile BTSs, as laid down by International Commission on Non-Ionizing Radiation Protection (ICNIRP) for limiting exposure to time-varying electric, magnetic, and electromagnetic fields up to 300 GHZ.

- e. Prepared Test Schedule for A/T of Mobile Number Portability (MNP) in consultation with all stakeholders.
- f. Established Satellite-based Broadband Network in NE Region.
- g. Developed technical requirement for Centralised Monitoring System (CMS) to handle the problems related to different Law Enforcement Agencies (LEA), different service providers to co-ordinate with number of different networks and nodes to be monitored.

TEC has been entrusted with the responsibilities of managing the recently established National Telecom Academy (NTA), for imparting training to its officers. TEC has commenced conducting courses, workshops and seminars on relevant topics.

Universal Service Obligation Fund (USOF)

The Universal Service Obligation Fund (USOF) formed by an Act of Parliament is headed by the Administrator, USO Fund, appointed by the Central Government, for the administration of the fund. He is empowered to formulate procedures for implementation of USO Fund schemes and disbursement of funds from USOF.

The organization is mandated to implement the schemes for infrastructure support for mobile services, Rural Broadband scheme for expanding provision of Wireline Broadband connectivity upto village level and Optical Fibre Network augmentation, creation and management of Intra-District SDHQ-DHQ-OFC network in service areas of North Eastern parts of the country and also the broadband connectivity upto Gram Panchayat by National Optical Fibre Network (NOFN).

SUBORDINATE OFFICE

- **Wireless Monitoring Organisation (WMO)**

Wireless Monitoring Organisation (WMO)

Wireless Monitoring Organisation (WMO) is providing the interference-free wireless services in the increasingly crowded radio environment besides providing vital technical data for the introduction of new services such as 3G, BWA etc to Wireless Planning & Coordination(WPC) wing.

FIELD OFFICES

- **O/o Controller of Communication Accounts (CCAs)**
- **Telecom Enforcement Resource Management (TERM) Cells**

Controller of Communication Accounts (CCAs)

There are 26 CCA Offices located all over the country. These offices are mandated to disbursement of terminal benefits, collection of licence fee, collection of spectrum charges, disbursement of USO fund disbursement..

These offices have evolved into a crucial professional interface between the DoT and its stakeholders on above matters.

Telecom Enforcement Resource Management (TERM) Cells

There are 34 TERM Cells located all over the country. These cells are mandated to monitoring to compliance to prescribed norms regarding acquisition of subscribers, compliance of to EMF radiation norms, verification of VLR data for requirement of additional spectrum/MSC codes by Licencees, curbing of illegal setups causing financial loss the exchequer, registration of other service providers, inspection of TSPs/subscribers. These Cells are also mandated to implement the Mobile Number Portability (MNP),

PUBLIC SECTOR UNDERTAKINGS (PSUs)

- Bharat Sanchar Nigam Ltd. (BSNL)
- Mahanager Telephone Nigam Ltd. (MTNL)
- Telecommunications Consultants India Ltd.
(TCIL)
- Bharat Broadband Network Limited (BBNL)

Bharat Sanchar Nigam Ltd. (BSNL)

Bharat Sanchar Nigam limited (BSNL) came in to existence on 1st October 2000 by corporatization of the erstwhile Department of Telecom Services and the Department of Telecom Operations. BSNL operates the telecom services all over the country except Mumbai and Delhi, where MTNL operates. BSNL is a 100% Government of India owned PSU with an authorized capital of Rs. 17,500 crores paid up capital of Rs. 12,500 crores and a staff strength of approximately 2.56 Lakhs. As on 31.03.2012, the market share of company is 69.88% in wire line and 10.71% in wireless. During the financial year 2011-12, the company has suffered a net loss of Rs. 8851 crores and loss incurred by the company upto 30.09.2012 is Rs 3655 crores. The undertaking also launched 3G services in the country in more than 8.50 cities till March, 2012.

Mahanagar Telephone Nigam Ltd. (MTNL)

Mahanagar Telephone Nigam Ltd (MTNL) was formed on April 1, 1986 to manage and control Telecommunication services in the two metropolitan cities of Delhi and Mumbai (including area under Thane Municipal Corporation). For Cellular services the company has license to provide the service in Delhi including peripheral towns of Gurgaon, Faridabad, Ghaziabad and Noida and in Mumbai including Kalyan. For internet service, the Company through Millennium Telecom Ltd. (MTL), a wholly owned subsidiary of MTNL, has an All India license to provide internet services. MTNL has been given Navratana status in 1997.

The Company has an authorized capital of Rs. 800 crores and paid up share capital of Rs. 630 crores. At present 56.25% of the equity is held by Government, and the remaining equity is held by FIs, Financial Institutions, Banks, Mutual Funds and others including individual investors.

During Financial year 2011-12, the company has made loss of Rs. 4109 crores. During 2012-13 (upto December, 2012) the company has incurred a loss of Rs. 3335 crores. The company launched 3G services in Delhi in December 2008 and in Mumbai in May 2009. The company has the market share 61% in wireline and, 7.4% in wireless Delhi & Mumbai. The strength of employee in the company is about 39,813 (upto December, 2012).

Telecommunications Consultants India Ltd. (TCIL)

On 10th March 1978, Telecommunications Consultants India Ltd. (TCIL) was incorporated as a wholly owned Government of India Company. The Company was set up with the objective of extending the wide ranging telecom expertise available with DOT to friendly developing countries. On August 1, 1978 the Company commenced its business. The Company has since then been engaged in adopting world class communication and IT technologies for catering to the local needs of countries mainly in the developing world. The Company is establishing itself in the changed Telecom & IT Scenario by successfully taking up and executing Wireless Network and Information Technology projects and diversify into other fields for which it has adequate competent man power.

The authorized capital of the Company is Rs. 60 crores and paid up capital is Rs. 43.20 crores. The total turn over during the year 2011-12 has reached 680.78 crores with the profit before tax to the extent of Rs. 19.15 crores (PBT). The MOU target is Rs.965 crores.

Indian Telephone Industries Ltd (ITI)

Indian Telephone Industries (ITI) Ltd. was set up in 1948 as a Departmental Undertaking of the Government of India at Bangalore. It was later christened as a Public Undertaking in January 1950. The Company has grown over the years and has now six manufacturing units all over the country i.e. at Bangalore, Naini, Rae Bareli, Mankapur, Palakkad and Srinagar (J&K). ITI offers total telecom solutions and manufactures a whole range of telecom equipment like telephone instruments, digital exchanges, transmission systems, BTS for GSM, Microwave, Optic Fibre communication equipment and VSAT (Very Small Aperture Terminal). Apart from this, ITI is in the business of deployment of total network on turnkey basis to BSNL, MTNL and Defence. ITI has also a strong in-house R&D, a dedicated Network System Unit for turnkey solutions and also a distribution network of Regional and Area Offices.

The authorized share capital of the Company is Rs. 700 crores while the paid up capital is Rs. 588 crores. The company however, has made continuous losses from 2003-04 onwards. In 2011-12 on a total turnover of Rs. 922 crores, the company has suffered a loss of Rs. 370 crores. The revival of ITI in to a profitable entity is under process which will include infusion of funds to clear the balance sheet of existing liabilities.

Bharat Broadband Network Limited (BBNL)

The optical fibre has predominantly reached state capitals, districts and blocks, at present. National Optical Fibre Network (NOFN) project is planned to connect all the 2,50,000 Gram Panchayats through optical fibre utilizing existing fibres of PSUs viz. BSNL, RailTel and Power Grid and laying incremental fiber wherever necessary to bridge the connectivity gap between Gram Panchayats and Blocks, for providing broadband connectivity.

Length of the incremental network is approx. 5 lakh Km. Dark fiber network thus created will be lit by appropriate technology to ensure a bandwidth of at least 100 Mbps at each Gram Panchayat.

Non-discriminatory access to the network will be provided to all categories of service providers. These access providers/service providers like mobile operators, Internet Service Providers (ISPs), cable TV operators, content providers can launch various services in rural areas.

Various applications for e-health, e-education, e-governance, e-commerce etc. will be provided. The project will be funded by Universal Service Obligation Fund and initial estimated cost of project is Rs. 20,000 crore in 2 years. The project was approved on 25 Oct. 2011.

The project is being executed by Public Sector Undertaking of DoT namely Bharat Broadband Network Limited (BBNL) which has been incorporated on 25.02.2012 under Indian Companies Act, 1956 as a Special Purpose Vehicle (SPV) to execute the National Optical Fibre Network (NOFN) project.

STATUTORY BODIES

- Telecom Regulatory Authority of India (TRAI)
- Telecom Disputes Settlement and Appellate Tribunal (TDSAT).

Telecom Regulatory Authority of India (TRAI)

With the entry of private sector in the provision of Telecommunication services a need was felt to have an independent regulatory body. The above requirement was indicated in the guidelines issued for entry of private sector in basic telecom service. Accordingly, Telecom Regulatory Authority of India (TRAI) was established in the year 1997 in pursuance of TRAI (Ordinance) 1997, which was later replaced by an Act of Parliament, to regulate the Telecommunication services.

TRAI is currently headed by Dr. Rahul Khullar, the former Commerce Secretary in the Ministry of Commerce & Industry, Government of India as Chairperson and has two whole time and two part time Members.

Some of the major recommendatory, regulatory and tariff setting functions of TRAI are to make recommendations on the need and timing for introduction of new service providers, of the terms and conditions of license to a service provider, ensure compliance of terms and conditions of license, effective management of spectrum lay down the standards of quality of service to be provided by the service providers and ensure the quality of service and conduct the periodical survey of such service provided by the service providers so as to protect interest of the consumers of Telecommunications service, ensure effective compliance of Universal Service Obligations, notify the rates at which Telecommunications services within India and outside India shall be provided under this Act etc.

Telecom Disputes Settlement and Appellate Tribunal (TDSAT)

Though the TRAI Act 1997 was envisaged to be comprehensive, certain issues had however emerged in its implementation which was hindering the growth of the telecom sector. The new Telecom Policy 1999 provided for strengthening of the Regulator. Accordingly, the TRAI Act was amended in the year 2000 to remove the ambiguities and strengthen the regulatory framework. The amendments made inter-alia included the separation of disputes settlement functions of TRAI to a separate disputes redressal body known as the Telecom Disputes Settlement and Appellate Tribunal with wide adjudicatory powers.

TDSAT has been empowered to adjudicate any dispute:

- Between a licensor and a licensee;
- Between two or more service providers;
- Between a service provider and a group of consumers;
- Hear and dispose of appeal against any direction, decision or order of TRAI.

Appeals against the order of the TDSAT lie to the Supreme Court. TDSAT consists of a Chairperson and not more than two Members appointed by the Central Government. Currently retired Supreme Court Justice D.P. Wadhwa is the Chairperson of the Tribunal.

Since its establishment TDSAT has adjudicated upon disputes on various matters on telecom including those matters pending before TRAI and transferred to it as a result of amendments made to TRAI Act.

AUTONOMOUS BODY

- Center for Development of Telematics (C-DOT)

Centre for Development of Telematics (C-DOT)

Centre for Development of Telematics (C-DOT) is an autonomous telecom research & development wing funded by the Department of Telecommunication. It was established under the Society Registration Act XXI in 1984 to design and develop indigenous switching technology. It has a three tier management system. The Apex body is the Governing Council chaired by the Hon'ble Minister of Communications & IT, a Steering Committee at the next level is chaired by Chairman Telecom Commission and at the third level, a Project Board comprising of Executive Director & three Directors for looking after day-to-day working of the centre. Research Engineers and technical support personnel constitute majority of C-DOT staff.

It has two main state of the art CMMI L3 certified research centres at Delhi & Bangalore respectively. The mandate of C-DoT is to develop state of art technologies and disseminate these technologies to Indian Telecommunication Manufacturers for mass production and value creation.

C-DOT is currently working on communication technologies for defence applications, security agencies and other projects of national importance like Rural Communication, Broadband and nodal agency for Lawful Interception. C-DOT is also giving importance to software intensive products and solutions including turnkey projects and to develop, build and operate model projects. Projects to cater to other national requirements to bridge the digital divide and those for North Eastern region and to develop enterprise and broadband solutions are also part of the schemes.

C-DOT's product portfolio includes Advanced Intelligent Network solutions Access Network products, Wavelength Division Multiplexing (WDM) Systems. Satellite Communication Systems, Network Management Systems, Operation Support Systems, Cell and Packet technologies for voice and data communications and Rural Wireless Access and Broadband Solutions based on Software defined and Cognitive Radio. C-DOT continues to support the legacy systems deployed in the field.

C-DOT has earlier worked on telecommunication technologies which constitute a large component of the Indian telecom network. In view of the changed telecom scenario in the country, C-DOT technologies are presently facing stiff competition from technologies of global telecom vendors. To address this challenge C-DOT has refocused its attention on developing core new generation technologies through a combination of in house technology development and development of technologies with strategic partners. These efforts will start yielding results early during new current five year plan period.

Annexure-A**Second Schedule to the Allocation of Business concerning
Department of Telecom**

Item No. of AoB	Entries*
1.	(i) Policy, Licensing and Coordination matters relating to telegraphs, telephones, wireless, data, facsimile and telematic services and other like forms of communications (ii) Framing of rules, related to security of telecom networks and coordination with Security agencies. (iii) Spectrum management and spectrum allocation.
2.	Cooperation and coordination with international bodies connected with Telecommunications.
3.	Promotion of standardisation, manufacturing, research and development in Telecommunications.
4.	Promotion of private investment in Telecommunications.
5.	Financial assistance for the furtherance of research and study in telecommunications technology and for building up adequately trained manpower for telecom programme, including assistance to institutions, assistance to scientific institutions and to universities for advanced scientific study and research.
6.	Telecom Commission

7.	<p>Administration of laws with respect to any of the matters specified in this list, namely:-</p> <p>The Indian Telegraph Act, 1885 (13 of 1885): and amendments from time to time</p> <p>The Indian Wireless Telegraphy Act, 1933 (17 of 1933) and amendments from time to time</p> <p>The Telecom Regulatory Authority of India Act. 1997 (24 of 1997) and amendments from time to time.</p>
8.	<p>Post disinvestment matters relating to M/s. Hindustan Teleprinters Ltd.</p>
9.	<p>Statutory Bodies</p> <p>(i) Telecom Regulatory Authority of India (TRAI)</p> <p>(ii) Telecom Disputes Settlement and Appellate Tribunal (TDSAT).</p>
10	<p>Attached Offices</p> <p>(i) Telecom Engineering Centre (TEC)</p> <p>(ii) Universal Service Obligation Fund (USOF)</p> <p>Subordinate office</p> <p>Wireless Monitoring Organization (WMO)</p>
11.	<p>Public Sector Undertakings (PSUs)</p> <p>(i) Bharat Sanchar Nigam Limited (BSNL)</p> <p>(ii) Mahanagar Telephone Nigam Limited (MTNL)</p> <p>(iii) Telecommunications Consultants (India) Limited (TCIL)</p> <p>(iv) Indian Telephone Industries (ITI)</p> <p>(v) Bharat Broadband Network Limited (BBNL)</p> <p>Autonomous Bodies</p> <p>Centre for Development of Telematics (C-DoT)</p>
12.	<p>Field offices</p> <p>(i) 26 Controller of Communication Accounts (CCAs) offices all over India</p> <p>(ii) 32 Telecom Enforcement Resource Management cells all over India.</p>

**(submitted to Cabinet Secretariat with the approval of MoC&IT)*

ORGANISATION CHART OF DEPARTMENT OF TELECOMMUNICATIONS

Minister of Communications & Information Technology

Minister of State for Communications & Information Technology

Secretary DoT & Chairman Telecom Commission

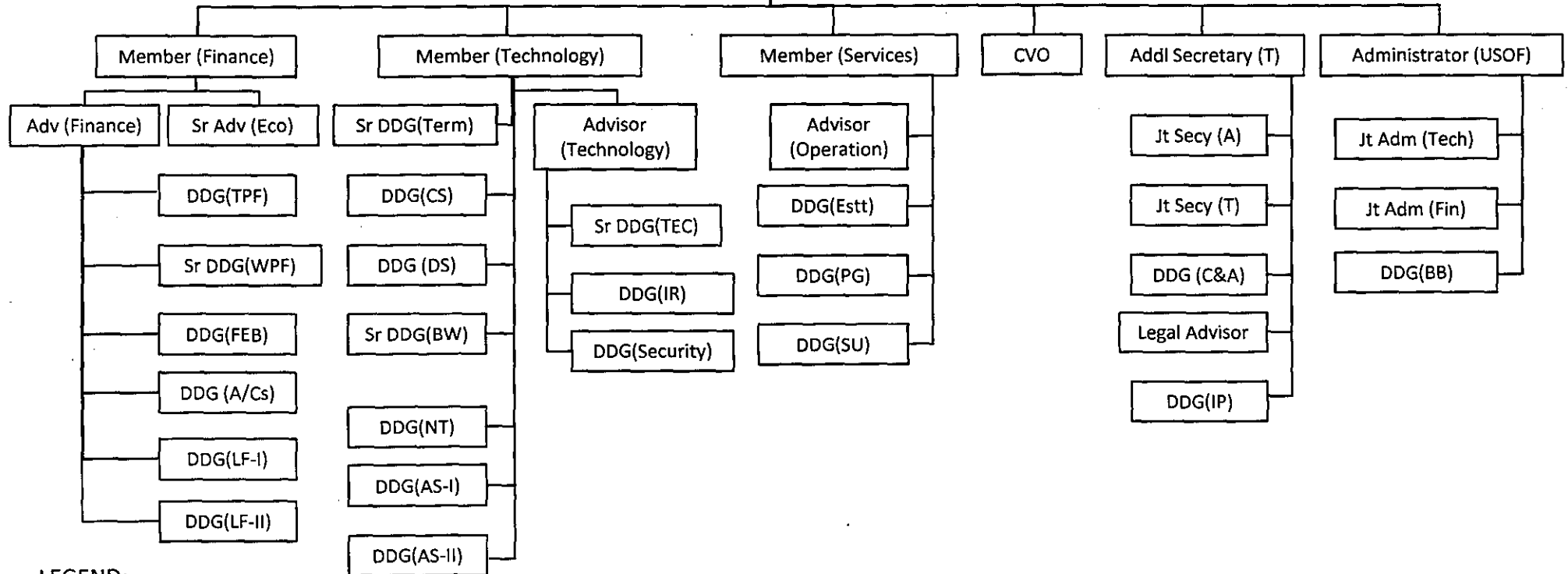

LEGEND:

DDG: Deputy Director General
 TPF: Tariff Public Enterprises Finance
 WPF: Wireless Planning Finance
 FEB: Finance, Establishment & Budget
 LF: Licensing Finance
 Eco: Economic

CS: Carrier Services
 DS: Data Services
 BW: Building Works
 NT: Networking
 AS: Access Services

TEC: Telecom Engineering Centre
 IR: International Relations

Estt: Establishment
 PG: Public Grievances
 SU: Service Unit

Jt Secy: Joint Secretary
 A: Administration
 T: Telecom
 C&A: Coordination & Administration
 IP: Investment Policy

USOF: Universal Services
 Obligation Fund
 Jt Adm. Joint Administrator
 Tech: Technology
 Fin: Finance
 BB: Broadband

ALLOCATION OF WORK
TO
AS(T)/MEMBERS/
ADMINISTRATOR (USOF)/CVO
&
THEIR DIVISIONAL HEADS
(Sr DDsG/JSs/Advisers/DDsG)

Allocation of work to Officers
under

1.0 **ADDITIONAL SECRETARY(T)** (MS. RITA TEAOTIA)

- JS (T)
- DDG (IP)
- JS (A)
- DDG(C&A)
- LEGAL ADVISER

1.1

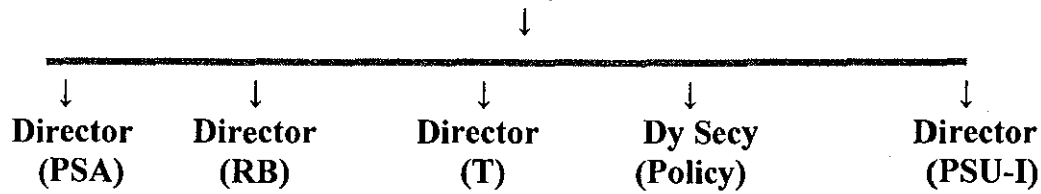
Joint Secretary (T) (Sh. V. Umashanker)

- i) Administration of TRAI Act and other administrative matters relating to TRAI and TDSAT. Telecom Commission Secretariat, National Telecom Policy, all matters relating to DOT restructuring other than those specifically allotted to other Wings.
- ii) Rural Telephony and Convergence issues.
- iii) Matters relating to FDI.
- iv) Investment promotion.
- v) Broadband Policy matters.
- vi) Board level appointments in PSUs.
- vii) WTO matters relating to Multilateral Bodies dealing with Telecommunications.
- viii) Telecom Centres of Excellence.
- ix) India Telecom Series Exhibitions
- x) Indo-British Telecom Forum
- xi) Sharing of Infrastructure
- xii) All administrative and operational matters relating to BSNL and MTNL
- xiii) Auction of 3G and Wi-Max Spectrum (Wireless Division will assist).
- xiv) All policy, administrative matters relating absorption of Gr. 'A' officers in the service PSUs – BSNL, MTNL. Work relating to the Consortium of Consultants appointed by the Govt. restructuring of MTNL and BSNL
- xv) Coordination matters with Deptt of Information Technology.
- xvi) Switching, transmission, commercial, marketing, planning, operation and maintenance, matters which exclusively relate to MTNL or where both BSNL and MTNL are involved and other issues which have not been assigned to any other officers.

1.2

DDG(IP) (R.K. Pathak)



Director (IP)

- (i) Formulation of investment policies and procedures for the Telecom Sector.
- (ii) Formulation of policies for development of telecom equipment manufacturing sector.
- (iii) Processing of applications for foreign investment and foreign technology in Telecom Sector
- (iv) Providing assistance in formulation of Import and Export policies for the Telecom Sector.
- (v) Export promotion of telecom equipment and service.
- (vi) Preparation of telecom proposals relating to Annual Budget.

1.3

Joint Secretary (A) (B B Kaura)



↓
**D y.Secy
(Admn.)**

↓
**Dy.Secy
(Admn.II)**

↓
**Jt. Director
(OL)**

- i) Implementation of Official language Act in DoT and its PSUs, Autonomous Bodies and Subordinate Offices.
- ii) Administration and cadre control of CSS, CSCS and other cadres Including WPC and loans and advances in DoT not under the control of Members of Telecom Commission, including Administration and Personnel Matters of Members(TC), officers under Central Staffing Scheme and officers /staff of CSS, CSSS dealt in Admn.I Section.
- iii) All VIP references and all Parliament Questions and other parliamentary matters relating to above subjects.
- iv) In the absence of JS(T), JS(A) would perform as Nodal Officer for all Cabinet Notes put up to Secretary.

1.4

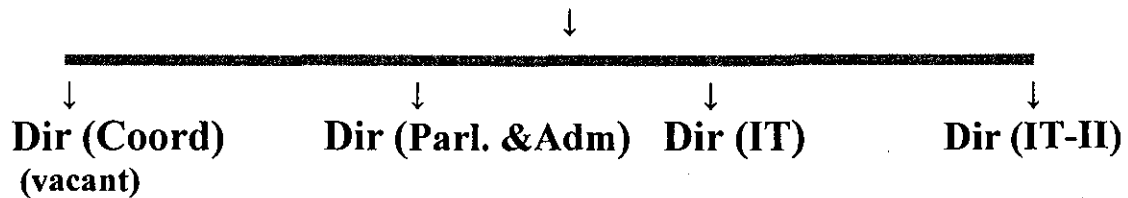
DDG (C&A) (S.C. Sharma)

- i) General co-ordination within various DoT divisions, and with Ministries.
- i) Matters relating to O&M procedures & maintenance of records.
- ii) Monitoring of VIP cases & action taken on Cabinet/Cabinet Committees' decisions
- iii) RTI Act and functions under RTI Act.
- iv) Reporting of important events of the department to Cabinet Secretariat
- v) IT infrastructures of DoT and inter-Ministerial co-ordination on IT matters including all items of work dealt in IT Cell.
- vi) General Administration (G-I & G-II), Printing and Publicity.
- vii) Parliament Section dealing with Parliament matters.
- viii) Central Registry and Records, CP&PR, Security, Purchase and Maintenance of Staff Car etc.
- ix) Sports.
- x) Welfare,
- xi) Protocol, Library
- xii) Canteen

1.5 Legal Adviser (S.K.Mohapatra)

↓

Dy Legal Adviser (vacant)

↓

Section Officer (Legal Cell)

- i) To render legal advice on all legal matters concerning DoT.
- ii) Attending meeting/discussions to elaborate upon or to resolve legal issues.
- iii) Advice on legislation including subordinate legislation, policy matters
- iv) Vetting of affidavit/reply/pleadings/ legal documents/ agreements etc. filed before Court or Tribunal
- v) Drafting of agreements/letter of intent/tender etc.
- vi) Review of pending court cases in DoT in FAG (legal) meeting
- vii) Instructions regarding handling of court cases
- viii) Advice on references received from PSUs under DoT.
- ix) Administrative and related matters.

Allocation of work to Officers

under

2.0 MEMBER (SERVICES) (S.C. Misra)

- Adviser (Operations)
 - DDG (SU)
- DDG (PG)
- DDG(Estt)

Adviser (Operation) (Ram Yagya)



2.1

DDG(SU) (N.K. Joshi)



↓
**Director
(PSU-II)**

↓
**Director
(SR)**

- i) Administrative matters of TCIL & ITI Ltd.
- ii) Residual matters relating to VSNL and HTL Ltd.
- iii) Matter relating to recognition of Unions/Associations of DoT.
- iv) Residual matters relating to staff quarters and rented buildings of BSNL/MTNL
- v) Coordination of matters relating to Unions/Associations of BSNL and MTNL
- vi) Matters relating to SC/ST/OBC/Physically Handicapped in SCT Cell
- vii) Work relating to C-DOT.

2.3

DDG (PG) (S.S. Singh)



↓
**Director
(PHP)**

↓
**Director
(PG)**

- i) Public Grievances and Customer Service.
- ii) Administration of Indian Telegraph Act.
- iii) Public grievance, Telephone Adalats, PCOs Directory Services, Customer Services of BSNL, MTNL.
- iv) Publication of Citizen Charter.

2.4 DDG (Establishment) (SC Sharma)

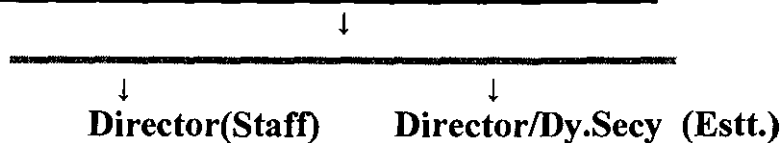

- i) Cadre control of service matters of Technical Telecom Cadres (ITS, TTS, TFS, TES Group-B and GCS) of the Deptt.
- ii) In respect of above, posting and transfers in DoT, permanent transfer/deputation from DoT to PSUs.
- iii) Policy matters involving pension, pay & allowances, medical reimbursement etc. in respect of all the above cadres.
- iv) PG cases of Pension on Pensioners Portal 'CPENGRAM'
- v) All HRD matters of BSNL, MTNL
- vi) Implementation of National Litigation Policy
- vii) All residual matters relating to Telecom Factory.

Allocation of work to Officers

under

3.0 MEMBER (TECHNOLOGY) (vacant)

- Adviser (Technology)
 - Sr DDG (TEC)
- Sr DDG (AS)
- DDG(IR)
- DDG(CS)
- DDG(DS)
- Sr DDG(BW)
- DDG(Security)
- Wireless Adviser

Adviser(Technology) (R.K. Bhatnagar)**3.1****Sr. DDG (TEC) (Anil Kaushal)**

All matters relating to Telecom Engineering Center.

- Specification approval
 - (i) Draft Specification
 - (ii) Departmental Sub Committee Meeting
 - (iii) Manufacturers Forum
 - (iv) DCC Meeting
 - (v) Approval of Specification
 - (vi) Amendment of specifications
- **Approval of certificates:**
 - (a) Interface approval Certificate against TEC IR
 - (b) Certificate of approval against applicant's own specifications
- Service Test Certificates for Licensed networks
- Action Plan
- Approval of GR deviation found during testing for type approval
- Technology approval C-DoT equipment
- Interaction with ITU-T for allocation of resources (such as International Signalling Point Code)
- Technical contribution to ITU-Y and ITU-R
- Participation of TRAI expert groups
- Advice/evolution of procurement of PABX by other Govt. Department/PSUs
- National Telecom Plans(Numbering, Signalling, Frequency)
- Fixation of test fees
- Conduct of the field trial and appraisal of for acceptance/non-acceptance
- New Technologies Trials
- Planning Advice to MTNL, BSNL
- R&D Council Cases, Technology Plan & Technical Consultancy
- Coordination of Technical matters of C-DoT, MTNL & BSNL.

Spectrum related issues

3.2

Sr. DDG (AS) (A.K.Mittal)

- | | | | | | |
|--|-------------------|--------------------|---------------------|-----------------|----------------|
| | ↓ | ↓ | ↓ | ↓ | ↓ |
| | Dir (AS-I) | Dir (AS-II) | Dir (AS-III) | Dir (IV) | Dir (V) |
- i) All matters relating to policy and issue of new Unified Access Services Licenses / Dual Technology Spectrum permissions.
 - ii) Coordination with other DoT cells and external agencies (IB, MHA, etc.) on policy matters, reports etc.
 - iii) Security matters on Mobile Services in Border areas 10km buffer zone issue, Subscriber verification, prepaid service in J&K, Assam and North east
 - iv) Next Generation Networks, interaction with security agencies, other Ministries, Vigilance Cells, issues raised by COAI/AUPI
 - v) Arbitration court cases TDSAT, Parliament Questions/Assurances and CIP cases, RTI cases on above matters
 - vi) UAS licenses, Numbering Plan administration, monthly subscribers data compilation of CDMA/ Basic operator, Unbundling, Right of Way issues, Interaction with IB/MHA.
 - vii) Subscribers verification of licenses, Mobile Money Transfer, CMTS/UAS licenses (Bharti, Vodafone, Idea, BSNL, MTNL, Spice, BPL)
 - viii) Interception and monitoring issues and issues raised by AUSPI.

3.6

Sr.DDG (BW) (P.K. Panigrahi)**Director (Civil)****Director (Electrical)**

- i) Administration and Cadre control of P&T BW(Gr.A) service relating to Civil, Electrical and Architectural disciplines.
- ii) All staff establishment matters relating to Gr.A & B of Civil Wing cadres of DoT(HQ), BSNL/MTNL.
- iii) Court cases on cadre and work related matters.
- iv) Arbitration cases.
- v) Energy conservation (EC Act 2001)
- vi) Inspection of Electrical installation
- vii) Non-conventional energy measures.
- viii) Environment protection (Noise and pollution Act 2002)

3.7

DDG (Security) (Ram Narain)**Director (Security-I)****Director (Security-II)**

- (i) Administrative coordination of 34 Telecom Enforcement, Resource & Monitoring (TERM) Cells, which broadly carry out the following functions:

Monitoring related functions:

- Subscriber Verification Audit to ascertain whether mobile service operators follow DoT guidelines for Customer verification before providing mobile connections.

Vigilance related functions:

- Inspection to curb illegal / clandestine grey market telecom activities
- Inspection of licensed Telecom Service Providers and ISPs
- Analysis of call/subscription/traffic data of various licensees. Security related functions:
- Technical arrangement for lawful interception / monitoring.

- (ii) Work related to Security related National Projects like Centralized System & Security Network, etc.

3.8

Wireless Adviser (R J S Kushwaha)**Jt. Wireless Adviser & Six Dy. Wireless Advisors**

- i) All matters relating to Spectrum Management, SACFA
- ii) International Telecommunication Union (ITU) coordination (Technical aspects).
- iii) Preparation of National Frequency Allocations Plans.
- iv) Spectrum management and issue of licences for Basic telephone services Wireless in Local Loop and CDMA based Cellular Services and all related aspects like technical examination & coordination of frequency assignment etc.
- v) Assignment of UHF & Microwave radio frequencies in respect of all users including Security Agencies, Government Organisation, Public Sector Undertaking, Private users.
- vi) Grant and renewal of various categories of Wireless Telegraph Station Licenses under the Indian Telegraph Act, 1885.

Allocation of work to Officers

under

4.0 MEMBER (FINANCE) (vacant)

▪ Adviser (Finance)

- Sr Economic Adviser
- Sr DDG (WPF)
- DDG(FEB)
- DDG(TPF & Accounts)
- DDG(LF-I)
- DDG(LF-II)

4.3 DDG(FEB) (Shikha Mathur Kumar)

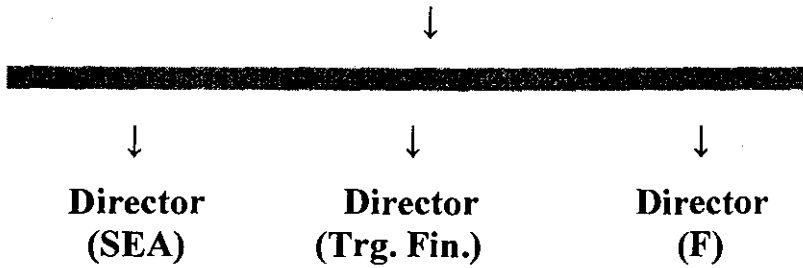

- i) Finance advice for DoT.
- ii) Budget of DoT.
- iii) Staff and Estt. matters exclusively relating to P&T Accounts and Finance Officers of DoT/ BSNL/ MTNL, including implementation of Government's Reservation Policy.
- iv) Preparation and monitoring of Five Year Plan proposals relating to DOT.
- v) Assets Management (Land & Building) in DoT.

4.4 DDG (TPF & Accounts) (Md. Shabaz Ali)

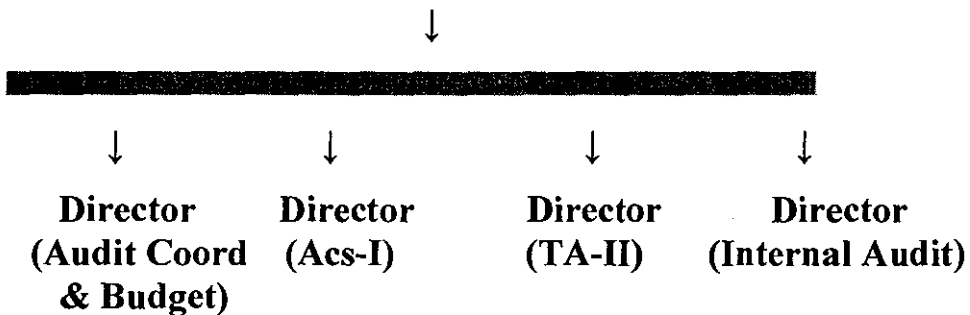

- (i) Audit Paras of DoT, its PSUs and C-DoT.
- (ii) Financial issues relating to DoT's PSUs and C-DoT.
- (iii) Tariff issues of Telecom Services.
- (iv) All financial matters relating to Finance, Billing, Telecom Revenue, Tariff Structure of BSNL, MTNL
- (v) Accounts matters of DoT, including monthly pay bills etc.

4.5 **DDG (LF-I) (K S Bariar)**



Director (LF-I)

- (i) Assessment of AGR and collection of license fees in r/o ISP. ISP with telephony, IP-II, VPN, Commercial VSAT, PMRTS, VSAT, Radio links, Microwave Services.
- (ii) Finalization of annual license fees and review of BGs in r/o above services & existing court cases.
- (iii) Manual for LF Branch and Computerization.

4.6 **DDG (LF-II) (S.K. Tiwari)**



Director (LF-II) Director (LF-III)

- (i) Assessment of AGR and license fees in respect of (i) Reliance Group of Companies (ii) Bharti Group of Companies (iii) MTNL (iv) Aircel (v) Loop (vi) Dishnet Wireless (viii) Sistema Shyam (MTS) and (viii) Etisalat.
- (ii) Verification of deductions and no dues certificate.
- (iii) Software of LF.
- (iv) Review of Data compilation and preparation of Memo for Telecom Commission..
- (v) Administration and staff matters.
- (vi) Review of compilation of assessment orders.
- (vii) Assessment of AGR and license fees in respect of (i) BSNL (ii) Tata Group of Companies (iii) Videocon Group of companies (iv) HFCL Group of Companies (v) S-Tel(vi) Vodafone Group of Companies (vii) IDEA, and (viii) UNINOR (Unitech Wireless).
- (viii) Parliament questions and VIP references.
- (ix) RTI Cases
- (x) Policy matters relating to LF Assessment.

Allocation of work to Officers

under

5.0 ADMINISTRATOR (USOF) (N. Ravi Shanker)

- Joint Administrator (Technology)
- DDG (USF-BB)
- Joint Administrator (Finance)

5.1 Jt. Administrator (Tech) USO Fund (I S Sastri)



Director (Tech-III)

Dy. Adm. (Tech)

Director (Tech-I)

- (i) Implementation of Universal Service Obligation Policy.
- (ii) To monitor progress of following schemes of USOF:
- (iii) (i) Provision of Village Public Telephones (VPTs) under Bharat Nirman.
- (iv) (ii) Provision of village Public Telephones (VPTs) in Newly Identified Villages of Census 2001.
- (v) Replacement of Multi Access Radio Relay Technology Village Public Telephone installed before 1st day of April 2002.
- (vi) Planning and Implementation of the subsequent phases of the schemes for provision of mobile services in the rural and remote areas of the country.
- (vii) Induction of new technological developments in the telecom sector on a Pilot Project basis in rural and remote areas.
- (viii) Implementation of Universal Service Obligation Policy.
- (ix) To Monitor progress of following schemes of USOF:
 - (a) Provision of Village Public Telephones (VPTs) under Bharat Nirman
 - (b) Provision of Village Public Telephones (VPTs) in Newly Identified Villages of Census 2001
 - (c) Replacement of Multi Access Radio Relay Technology Village Public Telephone installed before 1st day of April 2002
 - (d) The first Phase of the scheme for setting up of infrastructure sites for provision of mobile services in the rural and remote areas of the country.

5.2. **DDG(USF-Broad Band) (K.K. Minocha)**



Director (BB)

1. Implementation of Universal Service Obligation Policy with regard to Strengthening of OFC infrastructure in the rural areas, Extending wireless and satellite Broadband Connectivity in rural and remote areas.
2. To monitor progress of following schemes of USOF:
 - (i) Provision of Wireline Broadband Connectivity upto village level.
 - (ii) Optical Fibre Network Augmentation, Creation and Management of Intra-District SDHQ-DHQ OFC Network in service area of Assam.

5.3 **Jt. Administrator (Finance) (Kaushal Kishore)**



Dy. Admnr (F-I)

Dy. Admnr (F-II)

Dy. Admnr (F-IV)

- (i) Amendment to the terms and conditions of Agreement.
- (ii) Disposal of clarifications received from USPs and CCAs.
- (iii) Inspection reports.
- (iv) Static web pages of USOF website and other work relating to NIC.
- (v) Work relating to Finance Advice.
- (vi) Work relating to all the new activities including Broadband, Mobile Infrastructure, OFC network Gender budgeting Pilot Project etc.
- (vii) Development and management of claim Settlement and Management System (CSMS) part of the USOF website and other NIC related work.
- (viii) All on-going schemes of USOF.
- (ix) Mobile services phase-I
- (x) New schemes
- (xi) Outsourcing of work.
- (xii) Management of USOF website
- (xiii) Budgeting exercise and preparation of various estimates, Outcome Budget, Performance Budget.

- (xiv) Maintenance of information relating to intimation of claim and requisition of Fund.
- (xv) Authorization of Fund.
- (xvi) Maintenance of PBG(s).
- (xvii) Work relating to Audit.
- (xviii) Reconciliation of payment booking with TA Section
- (xix) Issues relating to staff and training.
- (xx) Budget Accounts and Audit matter
- (xxi) Delegation of financial powers
- (xxii) Establishment and Administration.

Allocation of work to Officers

under

6.0 **CHIEF VIGILANCE OFFICER (Pankaj Kumar)**

CVO (Chief Vigilance Officer)

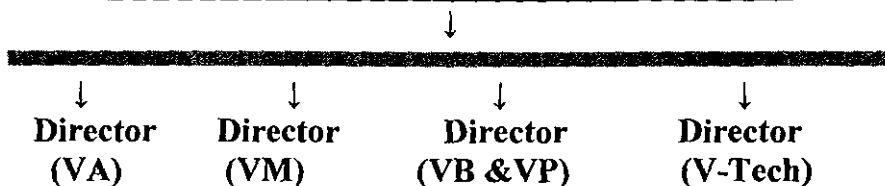

- i) All vigilance matters including CBI cases.
- ii) Processing of departmental disciplinary proceedings in respect of Group "A" officers of Department of Telecom belonging to Indian Telecom Service Group "A", Indian P&T Account and Finance Service Group "A", P&T Building Works Service Group "A" and Wireless Planning & Coordination Wing etc.
- iii) Prosecution & departmental vigilance cases referred by the CBI and other police agencies.
- iv) Court cases in respect of disciplinary cases. Appeal Review & Revision Petitions of Group "A" & "B" officers / officials.
- v) Investigation of complaints / cases having vigilance angle and monitoring and examination of Investigation Report (IR) pertaining to all Public Sector Undertakings under the administrative control of the Department viz. BSNL, MTNL, ITI, TCIL and C-DOT.
- vi) Ratification of penalty of absorbed officers.
- vii) Court cases arising from disciplinary cases appeals and review petitions.
- viii) Coordination with CVC for general subjects pertaining to Vigilance Wing.
- ix) Appointment of CVOs in Public Sector Undertakings under the control of DoT.

Public Sector Units, Statutory bodies and Autonomous Organisations under DOT